

# Service Manual

# THE FISHER®

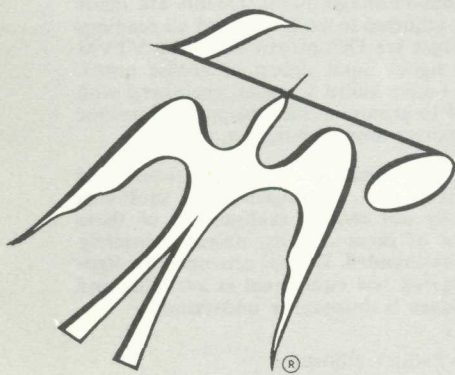
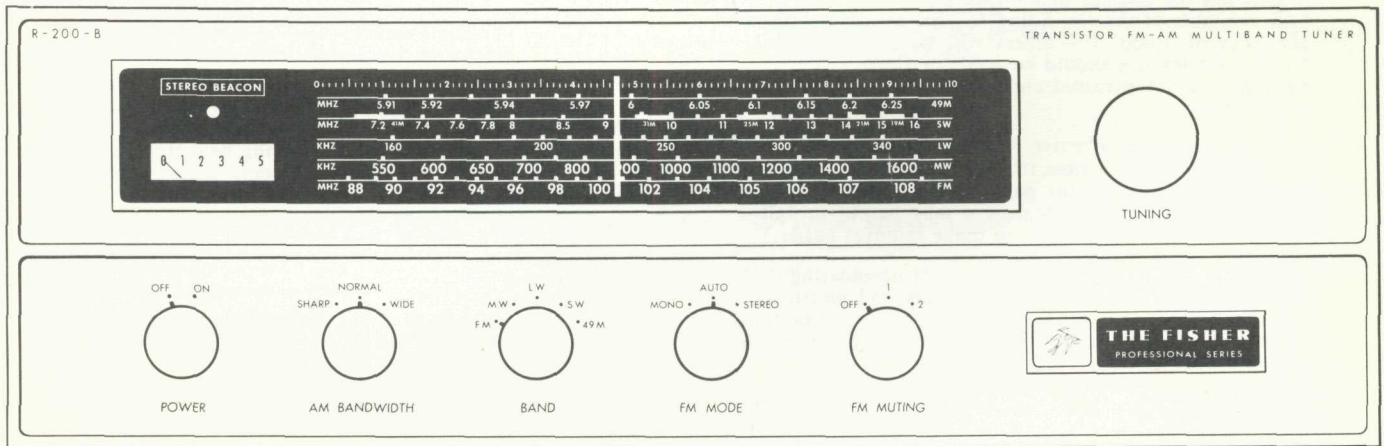

# R-200-B

\$1.00

CHASSIS SERIAL NUMBERS

BEGINNING 21001

FISHER RADIO CORPORATION • LONG ISLAND CITY 1 • NEW YORK

(c) www.fisherconsoles.com



**CAUTION:** This is a FISHER precision high-fidelity instrument. It should be serviced only by qualified personnel — trained in the repair of transistor equipment and printed circuitry.

### TEST EQUIPMENT REQUIRED

The following are needed to completely test and align modern high-fidelity instruments such as amplifiers, tuners and receivers.

Vacuum-Tube Voltohmmeter (100-mV DC scale)	10.7-MHz Sweep Generator
Audio Vacuum-Tube Voltmeter (10-mV AC scale)	455-kHz Sweep Generator
Oscilloscope (Flat to 100 kHz Minimum)	Line Voltage Autotransformer or Voltage Regulator
Audio (Sine-Wave) Generator	2 — Load Resistors, 4 or 8 Ohm, 50 Watt
Intermodulation Distortion Analyzer	2 — Full Range Speakers for Listening Tests
Harmonic Distortion Analyzer	Stereo Source — Turntable or Tape Recorder for Listening Tests
AM/FM Signal Generator	Soldering Iron with Small Tip Fully Insulated from Power Line
Multiplex Generator (preferably with RF output — FISHER Model 300 or equal)	Suction Desoldering Tool

### PRECAUTIONS

Many of these items are included just as a reminder—they are normal procedures for experienced technicians. Short-cuts can be taken but often they cause additional damage to transistors, circuit components or the printed-circuit board.

**Soldering**—A well-tinned, hot, clean soldering iron tip will make it easier to solder without damage to the printed-circuit board or the many circuit components mounted on it. It is not the wattage of the iron that counts — it is the heat available at the tip. Some 50-watt irons reach temperatures of 1,000° F — others will hardly melt solder. Small-diameter tips should be used for single solder connections — larger pyramid and chisel tips are needed for larger areas.

- When removing defective resistors, capacitors, etc., the leads should be cut as close to the body of the circuit component as possible. (If the part is not being returned for in-warranty factory replacement it may be cut in half — with diagonal-cutting pliers — to make removal easier.)
- Special de-soldering tips are made for unsoldering multiple-terminal units like IF transformers and electrolytic capacitors. By unsoldering all terminals at the same time the part can be removed with little chance of breaking the printed-circuit board.
- Always disconnect the chassis from the power line when soldering. Turning the power switch OFF is not enough. Power-line leakage paths, through the heating element, can destroy transistors.

**Transistors**—Never attempt to do any work on the transistor amplifiers without first disconnecting the AC linecord and waiting until the power supply filter-capacitors have discharged.

- Guard against shorts — it takes only an instant for a base-to-collector short to destroy that transistor and possibly others direct-coupled to it. [In the time it takes for a dropped machine screw, washer or even the screwdriver, to glance off a pair of socket terminals (or between a terminal and the chassis) a transistor can be ruined.]
- DO NOT bias the base of any transistor to, or near, the same voltage applied to its collector.
- DO NOT use an ohmmeter for testing transistors. The voltage applied through the test probes may be higher than the base-emitter breakdown voltage of the transistor.

**Output Stage and Driver — Replacements for output and**

**driver transistors, if necessary, must be made from the same beta group as the original type. The beta group is indicated by a colored dot on the mounting flange of the transistor. Be sure to include this information, when ordering replacement transistors.**

- If one output transistor burns out (open or shorts), always remove ALL output transistors in that channel and check the bias adjustment, the control and other parts in the network with an ohmmeter before inserting a new transistor. All output transistors in one channel will be destroyed if the base-biasing circuit is open on the emitter end.
- When mounting a replacement power transistor be sure the bottom of the flange, the mica insulator and the surface of the heat sink are free of foreign matter. Dust and grit can prevent perfect contact reducing heat transfer to the heat sink. Metallic particles can puncture the insulator and cause shorts — ruining the transistor.
- Silicone grease must be used between the transistor and the mica insulator and between the mica and the heat sink for best heat conduction. (Use Dow-Corning DC-3 or C20194 or equivalent compounds made for power transistor heat conduction.)

- Use care when making connections to speakers and output terminals. Any frayed wire ends can cause shorts that may burn out the output transistors — they are direct-coupled to the speakers. To reduce the possibility of shorts at the speakers, lugs should be used on the exposed ends or at least the ends of the stranded wires should be tinned to prevent frayed wire ends. The current in the speakers and output circuitry is quite high. Poor contacts or small size wire can cause power losses in the speaker system. Use 14 or 16 AWG for long runs of speaker wiring.

**Voltage Measurements**—Voltage measurements are made with the line voltage adjusted to 117 volts and all readings are  $\pm 10\%$ . All voltages are DC, measured with a VTVM to ground, with no signal input unless otherwise noted.   indicates 1-kHz audio voltages, measured with an audio AC VTVM to ground at various points from the phono input to the power amplifier output.

**Alignment Procedures — Replacement of transistors and components in the front end, IF amplifier and multiplex decoder will normally not require realignment of these circuits. Realignment of these circuits, unless absolutely necessary, is not recommended. Do not attempt a realignment unless the required test equipment is available and the alignment procedure is thoroughly understood.**

BECAUSE ITS PRODUCTS ARE SUBJECT TO CONTINUOUS IMPROVEMENT, FISHER RADIO CORPORATION RESERVES THE RIGHT TO MODIFY ANY DESIGN OR SPECIFICATION WITHOUT NOTICE AND WITHOUT INCURRING ANY OBLIGATION.

© COPYRIGHT 1966 FISHER RADIO CORPORATION All Rights Reserved

(c) www.fisherconsoles.com



## SERVICE PROCEDURES

### DIAL STRINGING

- Remove dial pointer.
  - Lift out left dial glass lamp and remove screw holding left side of dial glass panel.
  - Remove two screws holding right side of dial glass panel.
  - Pull dial glass panel towards left and tilt the panel down as far as the leads allow.
  - Rotate the tuning capacitor drive drum to its maximum counter-clockwise position.
  - Tie end of dial cord to the end of small spring A. Fasten spring to ear inside the drive drum (Figure 1).
  - Run the dial cord through the slot in the rim of the drive drum and set in the underside of groove 1 (side view).
  - Pull dial cord taut and wrap  $1\frac{1}{2}$  turns around the flywheel shaft.
  - Rotate the tuning capacitor drive drum to its maximum clockwise position, allowing the dial cord to follow the grooves in the drive drum (Figure 2). Keep the dial cord taut during this procedure.
  - Guide the dial cord over the top of the drive drum and place it in groove 3 (top view).
  - Run the dial cord through the slot in the drive drum and bring it under and around the beveled washer. Pull the dial cord taut and tighten the machine screw to hold the dial cord under the washer.
  - Rotate tuning capacitor drive drum to its maximum counter-clockwise position.
  - Run loose end of dial cord out through the slot in the drive drum and place it in groove 3 (Figure 3). Guide the dial cord through pulleys A and B.
  - Rotate the tuning capacitor drive drum to its maximum clockwise position. Keep the dial cord taut during this procedure.
  - Guide the dial cord under the drive drum into groove 5 (Figure 4). Bring the dial cord up and around groove 6 and into the slot in the drive drum.
- NOTE: Check that there is an empty groove between this turn and the next to last turn of dial cord on the drum.
- Loosen the machine screw. Pull the dial cord taut until adjusting spring B stretches open and pulley bracket A stands straight up. Place the cord under the beveled washer and tighten the machine screw.
- CAUTION: Do not disturb dial cord already placed under the washer.
- Replace the dial glass panel using the first three steps in reverse order.
  - Replace the dial pointer on the top of the dial glass panel.

### REPLACING METER LAMP

- Disconnect AC power cord.
- Remove screws which hold top cover to the chassis and lift off the top cover.
- Gently push in on the lamp and turn it counterclockwise to remove. Remove the metal lamp shade and place it on the new lamp in the same position. Place the new lamp in the socket, push in gently and turn it clockwise to lock it in place.
- Replace the top cover and secure with the screws removed previously.

### REPLACING STEREO BEACON LAMP

- Disconnect AC power cord.
- Remove screws which hold top cover to the chassis and lift off the top cover.
- Pry nylon lamp holder from the lamp mount. Unsolder the leads from the lamp holder. Solder leads to rear terminals on the new lamp holder. Place new lamp holder in the mount.
- Replace the top cover and secure with the screws removed previously.

### REPLACING DIAL LAMPS

- Disconnect AC power cord.
- Gently pull all knobs off the front panel control shafts. Remove the hex nuts from the control shafts and lift off the front panel.
- Snap out the defective lamp from the spring clip. Place the new lamp in the socket making sure that the unpainted side of the lamp faces the edge of the dial glass.
- Replace the front panel and secure with the hex nuts removed previously. Replace the knobs on the control shafts.

### CLEANING DIAL GLASS

- Disconnect AC power cord.
- Gently pull all knobs off the front panel control shafts. Remove the hex nuts from the control shafts and lift off the front panel.
- If there are foam-cushion strips located at the ends of the dial glass, remove them.
- Loosen the screws that hold the retaining clips to the dial glass. Swing the clips aside and lift off the dial glass.
- Remove dust with a dry cloth. If you wish to clean more thoroughly, use a soap-and-water solution only, any stronger cleaning agent may damage the markings on the glass.
- Replace the dial glass and position it down and towards the left of the chassis front. Swing the retaining clips back into place and tighten the retaining-clip screws. Replace the foam-cushion strips, if removed previously.
- Replace the front panel and secure with the hex nuts removed previously. Replace the knobs on the control shafts.

### CLEANING FRONT PANEL

WARNING: Use only plain lukewarm water and a freshly laundered, soft lint-free cloth to clean the front control panel.

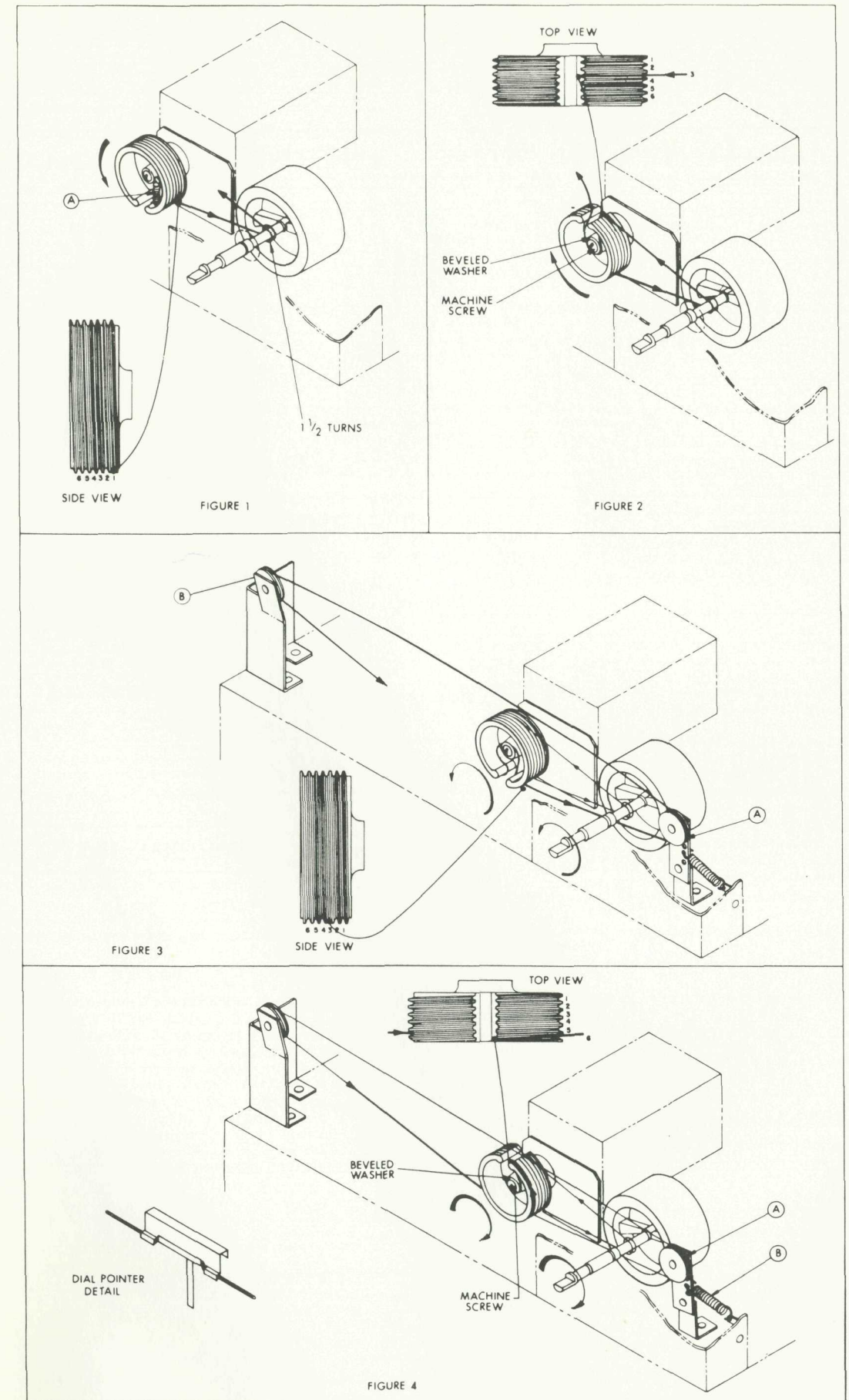



## SERVICE PROCEDURES

### FM FRONT END ALIGNMENT

**NOTE:** FM IF alignment must be performed before starting this procedure.

Set BAND switch to FM.

- Set TUNING dial pointer to zero (0) calibration mark on the logging scale. If the dial pointer does not coincide with the 0 at the extreme end of the knob rotation, reposition the pointer assembly on the dial cord and cement the pointer in place to prevent slippage.

**NOTE:** Moving the dial pointer will make realignment of the MW, LW, SW and 49-M bands necessary.

- Connect DC VTVM to Test Point 301 on the IF board.
- Connect an RF generator to the NORM antenna terminals. Use a 120-ohm composition resistor in series with each lead from the generator—see Figure 1.
- Set RF generator frequency and TUNING dial pointer to 90 MHz (Mc). DO NOT USE MODULATION (AM or FM) and keep the generator output as low as possible during the alignment procedure.
- Align FM oscillator coil (L754) core first—then align the FM mixer coil (L753) and FM RF coil (L752) cores for maximum reading on DC VTVM.
- Set RF generator frequency and TUNING dial pointer to 106 MHz (Mc).
- Adjust FM oscillator trimmer (C518) first—then adjust the FM mixer trimmer (C765) and FM RF trimmer (C760) for maximum reading on DC VTVM.
- Adjust FM antenna coil (L751) for maximum DC VTVM reading. Keep the generator output as low as possible.
- Repeat alignment several times until accurate dial calibration and maximum gain are obtained. Keep the generator output as low as possible during all adjustments.

### FM IF ALIGNMENT

- Connect 10.7-MHz (Mc) sweep generator to Test Point 751 on front end. Disconnect jumper between terminals 3F and 3G on IF board. Connect scope vertical input through 220K resistor to Test Point 301.

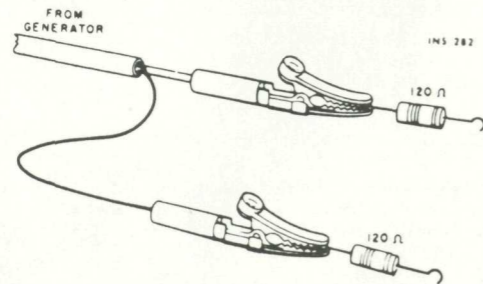

FIGURE 1. CONNECTIONS TO PROVIDE 300-OHM GENERATOR OUTPUT IMPEDENCE. MATCHING RESISTORS REDUCE GENERATOR VOLTAGE BY HALF AT THE ANTENNA TERMINALS.

**NOTE:** Connect ground lead of generator to ground near Test Point 751 and ground of scope closest to scope input.

- Adjust generator output voltage and frequency to observe IF response curve. Use as low a generator output as possible. Measure voltage at Test Point 301 with DC VTVM during alignment and readjust generator output to keep meter reading between -1.4 to -2.0 VDC maximum.
- Detune top core of Z303 outwards.
- Align bottom core of Z303, top and bottom cores of Z302, Z301 and Z751 for maximum gain and symmetry—see Figure 2. Repeat alignment.
- Reconnect jumper between terminals 3F and 3G. Disconnect wire and 0.02- $\mu$ F capacitor from Test Point 302 (terminal 3N) and connect scope vertical input through 220K resistor to Test Point 302.
- Align top core of Z303 for maximum gain and symmetry—see Figure 3.
- Disconnect scope and reconnect wire and 0.02- $\mu$ F capacitor to Test Point 302. Connect DC VTVM to Test Point 302.
- Set generator output to 10.7 MHz (Mc) with no sweep. Vary generator voltage from minimum to maximum; reading on DC VTVM should increase with increase in signal.
- Connect DC VTVM across resistor R11. Vary generator voltage from minimum to maximum; reading on DC VTVM should decrease with increase in signal.
- Set generator voltage to 200 mV. Adjust FM Meter Adjust Pot. R55 for tuning meter reading of 4.
- Connect scope vertical input through 220K resistor to terminal 3K.
- Set generator for sweep and adjust generator output voltage to observe ratio detector response. Use as low a generator output as possible.
- Adjust top and bottom cores of Z304 for maximum gain; readjust top core for best linearity—see Figure 4.

### FM TUNING METER CALIBRATION

- Connect an FM generator to the NORM antenna terminals. Use a 120-ohm composition resistor in series with each lead from the generator—see Figure 1.

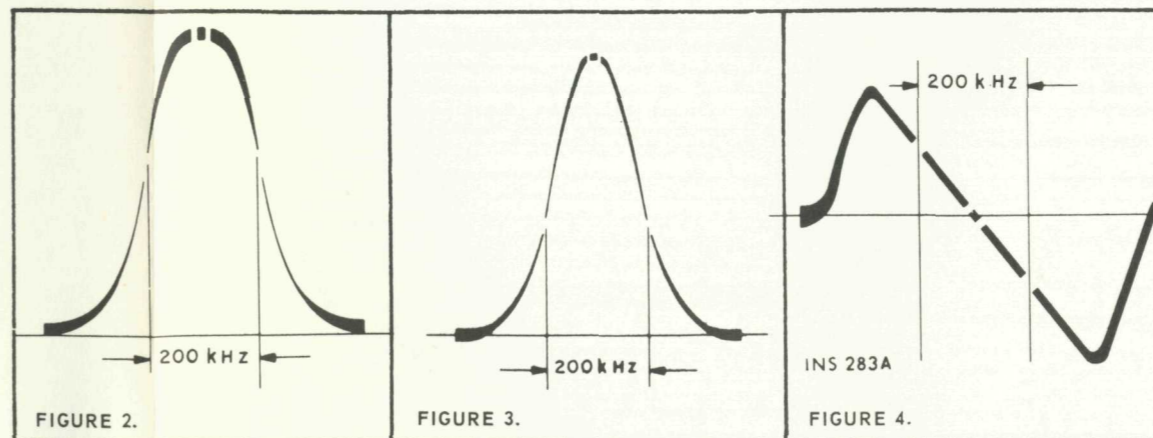

- Set FM generator frequency and TUNING dial pointer to 90 MHz (Mc). Set generator output to 20 mV,  $\pm 22.5$  kHz (kc) deviation with 400 Hz (cps).
- Adjust top core of Z303 for maximum reading on tuning meter.
- Increase generator output to 200 mV. Adjust FM Meter Adjust Pot. R55 for meter reading of 4.5.

### FM MUTING ADJUSTMENT

Set FM MUTING switch to OFF.

- Connect an FM generator to the NORM antenna terminals. Use a 120-ohm composition resistor in series with each lead from the generator—see Figure 1.
- Connect AC VTVM to LEFT or RIGHT CHANNEL MAIN jack.
- Set FM generator frequency and TUNING dial pointer to 90 MHz (Mc). Set generator output to 1 mV,  $\pm 22.5$  kHz (kc) deviation with 400 Hz (cps).
- Adjust TUNING knob for maximum reading on tuning meter. Note reading on AC VTVM.
- Set FM MUTING switch to 1. Adjust Muting Threshold Pot. R63 for reading on AC VTVM 2 db lower than that previously noted.
- Reduce generator voltage to zero—no signal (400 Hz modulation) or noise should be indicated on AC VTVM at MAIN jack.

### AM TUNING METER CALIBRATION

Set BAND switch to MW and AM BANDWIDTH switch to NORMAL.

- Connect AM generator, set for 100 mV output to the EXT antenna terminal through a 220-pF capacitor. Open the shorting link.
- Set AM generator and TUNING dial pointer to 1 MHz (Mc).
- Adjust AM Meter Adjust Pot. R57 for a meter reading of 4.



## SERVICE PROCEDURES

### MULTIPLEX ALIGNMENT

Two methods of aligning the multiplex decoder are given. The preferred procedure uses a multiplex generator with RF and 19 kHz (kc) outputs and with 1 kHz (kc) modulation, such as the Fisher Model 300 Multiplex Generator. This is the better method of alignment since the front end and IF stages are also checked through the use of this procedure. An alternate procedure for use with multiplex generators not having an RF output is also given.

### PREFERRED ALIGNMENT PROCEDURE

Set BAND switch to FM, FM STEREO MODE switch to AUTO and FM MUTING switch to OFF.

- Connect multiplex generator to the NORM antenna terminals. Use a 120-ohm composition resistor in series with each lead from the generator.
- Follow procedures given in Table 1 below.

**NOTE:** Check the alignment of the IF amplifier before aligning the MPX decoder. Poor IF alignment can make proper multiplex adjustment impossible.

### ALTERNATE ALIGNMENT PROCEDURE

Set BAND switch to FM, FM STEREO MODE switch to AUTO and FM MUTING switch to OFF.

- Disconnect wire going to connection 4C on the multiplex board. Connect MPX generator to connection 4C.
- Follow procedures given in Table 2 below.
- After alignment is complete, disconnect MPX generator and reconnect lead coming from connection 3K on the IF board to connection 4C on the multiplex board.

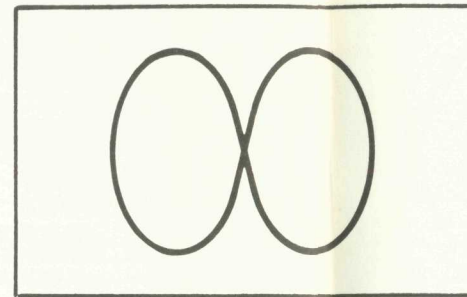

FIGURE 1. LISSAJOUS PATTERN FOR MPX ALIGNMENT:

TABLE 1 - MULTIPLEX ALIGNMENT USING RF MULTIPLEX SIGNAL

STEP	GENERATOR MODULATION	RF DEV.	INDICATOR TYPE AND CONNECTION	ALIGNMENT	
				ADJUST	INDICATION
1	19kHz (kc) pilot only.	±7.5kHz (kc)	DC VTVM to TP401.	Z401 top & bottom, Z402	Maximum DC VTVM reading.
2	Same as Step 2.	no mod.	DC VTVM to connection 4F.	Trigger Control	Stereo Beacon lights up with 0.8V reading on DC VTVM.
3	Connect portion of 19kHz (kc) generator output to scope horizontal input.	no mod.	Vertical scope input through 1 megohm resistor to TP403; scope set for external sweep	Z403 top	Stable Lissajous pattern 2:1 (Figure 1) as slow moving as possible.
4	Same as Step 3.	no mod.	Same as Step 3.	Z403 bottom	Maximum scope amplitude; adjust Z403 top as necessary for slow moving Lissajous.
5	Composite MPX signal 1kHz (kc) on left channel only.	±75kHz (kc)	Audio (AC) VTVM and scope input to left channel output (connection 4H).	Z402	Maximum audio AC VTVM reading; clean 1kHz (kc) sine wave on scope.
6	Composite MPX signal 1kHz (kc) on right channel only.	±75kHz (kc)	Same as Step 5.	Separation Control	Minimum audio AC VTVM reading—at least 35db below reading in Step 5.
7	Same as Step 6.	±75kHz (kc)	Audio (AC) VTVM and scope input to right channel output (connection 4K).	—	Same audio AC VTVM reading as obtained in Step 5 (±2db); clean 1kHz (kc) sine wave on scope.
8	Same as Step 5.	±75kHz (kc)	Same as Step 7.	—	Minimum audio AC VTVM reading—at least 35 db below reading in Step 7.

TABLE 2 - MULTIPLEX ALIGNMENT USING COMPOSITE MULTIPLEX SIGNAL

STEP	GENERATOR MODULATION	LEVEL (RMS)	INDICATOR TYPE AND CONNECTION	ALIGNMENT	
				ADJUST	INDICATION
1	19kHz (kc) pilot only.	Vary 0 to 50mV	DC VTVM to TP401.	Z401 top & bottom, Z402	Maximum DC VTVM reading.
2	Same as Step 2.	15mV	DC VTVM to connection 4F.	Trigger Control	Stereo Beacon lights up with 0.8V reading on DC VTVM.
3	Connect portion of 19kHz (kc) generator output to scope horizontal input.	Vary 10 to 50mV	Vertical scope input through 1 megohm resistor to TP403; scope set for external sweep.	Z403 top	Stable Lissajous pattern 2:1 (Figure 1) as slow moving as possible.
4	Same as Step 3.	Vary 10 to 50mV	Same as Step 3.	Z403 bottom	Maximum scope amplitude; adjust Z403 top as necessary for slow moving Lissajous.
5	Composite MPX signal 1kHz (kc) on left channel only.	100mV (560mV P-P)	Audio (AC) VTVM and scope input to left channel output (connection 4H).	Z402	Maximum audio AC VTVM reading; clean 1kHz (kc) sine wave on scope.
6	Composite MPX signal 1kHz (kc) on right channel only.	100mV (560mV P-P)	Same as Step 5.	Separation Control	Minimum audio AC VTVM reading—at least 35db below reading in Step 5.
7	Same as Step 6.	100mV (560mV P-P)	Audio (AC) VTVM and scope input to right channel output (connection 4K).	—	Same audio AC VTVM reading as obtained in Step 5 (±2db); clean 1kHz (kc) sine wave on scope.
8	Same as Step 5.	100mV (560mV P-P)	Same as Step 7.	—	Minimum audio AC VTVM reading—at least 35db below reading in Step 7.



AM ALIGNMENT

AM IF ALIGNMENT

Set BAND switch to MW and AM BANDWIDTH switch to SHARP.

● Connect oscilloscope vertical input to the cathode of the AM detector diode through a 100-kilohm resistor. Connect a 100-pF capacitor across the scope input. Connect oscilloscope horizontal input to sweep generator.

● Connect AM sweep generator, set for 455 kHz (kc) with a 30 kHz (kc) sweep, to the base of AM mixer transistor Q504 through a 5000-pF capacitor.

● Set marker generator for markers at 452.5, 455 and 457.5 kHz (kc).

● Adjust AM generator output for a 1 volt peak-to-peak waveform on the oscilloscope. Maintain generator output at this level during all adjustments.

● Adjust primary and secondary cores of IF transformers Z1, Z2 and Z3 for maximum indication on the scope of the 455 kHz (kc) marker on the waveform.

● Set AM BANDWIDTH switch to NORMAL.

● Readjust secondary core of IF transformer Z3 for flat IF response waveform.

**NOTE:** IF alignment must be performed before starting MW, LW, SW and 49M alignment.

AM MW-BAND ALIGNMENT

Set BAND switch to MW and AM BANDWIDTH switch to SHARP.

● Connect AC VTVM and an oscilloscope to the LEFT or RIGHT CHANNEL MAIN output jack. Use scope to monitor the output waveform.

● Connect AM generator, set for 30% modulation at 400 Hz (cps), to the EXT antenna terminal through a 220-pF capacitor. Open the shorting link and adjust the generator output for a meter reading of 0.2 V RMS.

**NOTE:** Keep the generator output as low as possible to maintain the meter reading below 0.2 V RMS during all adjustments.

● Set AM generator and tuner dials to 600 kHz (kc).

● Adjust MW oscillator coil (L509) core first—then adjust the MW RF coil (L506) core and the antenna coil for maximum AC VTVM reading.

**NOTE:** To adjust the antenna coil, melt the wax holding the small coil to the end of the ferrite antenna. Shift the coil back and forth for maximum meter reading. Secure coil in place with melted wax.

● Set AM generator and tuner dials to 1400 kHz (kc).

● Adjust MW oscillator trimmer (C529) first—then adjust the MW RF trimmer (C516) and the antenna trimmer (C501) for maximum AC VTVM reading.

● Repeat oscillator, RF and antenna alignment several times until accurate calibration and maximum gain are obtained.

AM LW-BAND ALIGNMENT

Set BAND switch to LW and AM BANDWIDTH switch to SHARP.

● Connect AC VTVM and an oscilloscope to the LEFT or RIGHT CHANNEL MAIN output jack. Use scope to monitor output waveform.

● Connect AM generator, set for 30% modulation at 400 Hz (cps), to the EXT antenna terminal through a 220-pF capacitor. Open the shorting link and adjust the generator output for a meter reading of 0.2 V RMS.

**NOTE:** Keep the generator output as low as possible to maintain the meter reading below 0.2 V RMS during all adjustments.

● Set AM generator and tuner dials to 170 kHz (kc).

● Adjust LW oscillator coil (L508) core first—then adjust the LW RF coil (L505) and the antenna coil (L502) cores for maximum AC VTVM reading.

● Set AM generator and tuner dials to 330 kHz (kc).

● Adjust LW oscillator trimmer (C527) first—then adjust the LW RF trimmer (C515) and the antenna trimmer (C508) for maximum AC VTVM reading.

● Repeat oscillator, RF and antenna alignment several times until accurate calibration and maximum gain are obtained.

AM SW-BAND ALIGNMENT

Set BAND switch to SW and AM BANDWIDTH switch to SHARP.

● Connect AC VTVM and an oscilloscope to the LEFT or RIGHT CHANNEL MAIN output jack. Use scope to monitor output waveform.

● Connect AM generator, set for 30% modulation at 400 Hz (cps), to the EXT antenna terminal through a 390-ohm composition resistor. Open the shorting link and adjust the generator output for a meter reading of 0.2 V RMS.

**NOTE:** Keep the generator output as low as possible to maintain the meter reading below 0.2 V RMS during all adjustments.

● Set AM generator and tuner dials to 7.5 MHz (Mc).

● Adjust SW oscillator coil (L507) core first—then adjust the SW RF coil (L504) and the antenna coil (L501) cores for maximum AC VTVM reading.

**NOTE:** To check that the oscillator is not tuned to the image frequency, increase the generator output about 60 db and slowly screw the oscillator coil (L507) core outward 3 turns. If no increase in the meter reading is obtained, return the core to its original position and reduce the generator output to normal.

● Set AM generator and tuner dials to 14 MHz (Mc).

● Adjust SW oscillator trimmer (C535) first—then adjust the SW RF trimmer (C514) and the antenna trimmer (C502) for maximum AC VTVM reading.

**NOTE:** To check that the oscillator is not tuned to the image frequency, increase the generator output about 40 db and slowly screw the oscillator trimmer (C535) outward 3 turns. If no increase in the meter reading is obtained, return the trimmer to its original position and reduce the generator output to normal.

**NOTE:** During adjustments of the RF trimmer (C514), a slight pulling of the oscillator frequency may be noted. To obtain accurate alignment, rock the TUNING dial during the final adjustment.

● Repeat oscillator, RF and antenna alignment several times until accurate calibration and maximum gain are obtained.

AM 49M-BAND ALIGNMENT

Set BAND switch to 49M and AM BANDWIDTH switch to SHARP.

● Connect AC VTVM and an oscilloscope to the LEFT or RIGHT CHANNEL MAIN output jack. Use scope to monitor waveform.

● Connect AM generator, set for 30% modulation at 400 Hz (cps), to the EXT antenna terminal through a 390-ohm composition resistor. Open the shorting link and adjust the generator output for a meter reading of 0.2 V RMS.

**NOTE:** Keep the generator output as low as possible to maintain the meter reading below 0.2 RMS during all adjustments.

● Set AM generator and tuner dials to 6.05 MHz (Mc)

● Adjust 49M oscillator trimmer (C534) first—then adjust the 49M RF trimmer (C520) and the antenna trimmer (C505) for maximum AC VTVM reading.

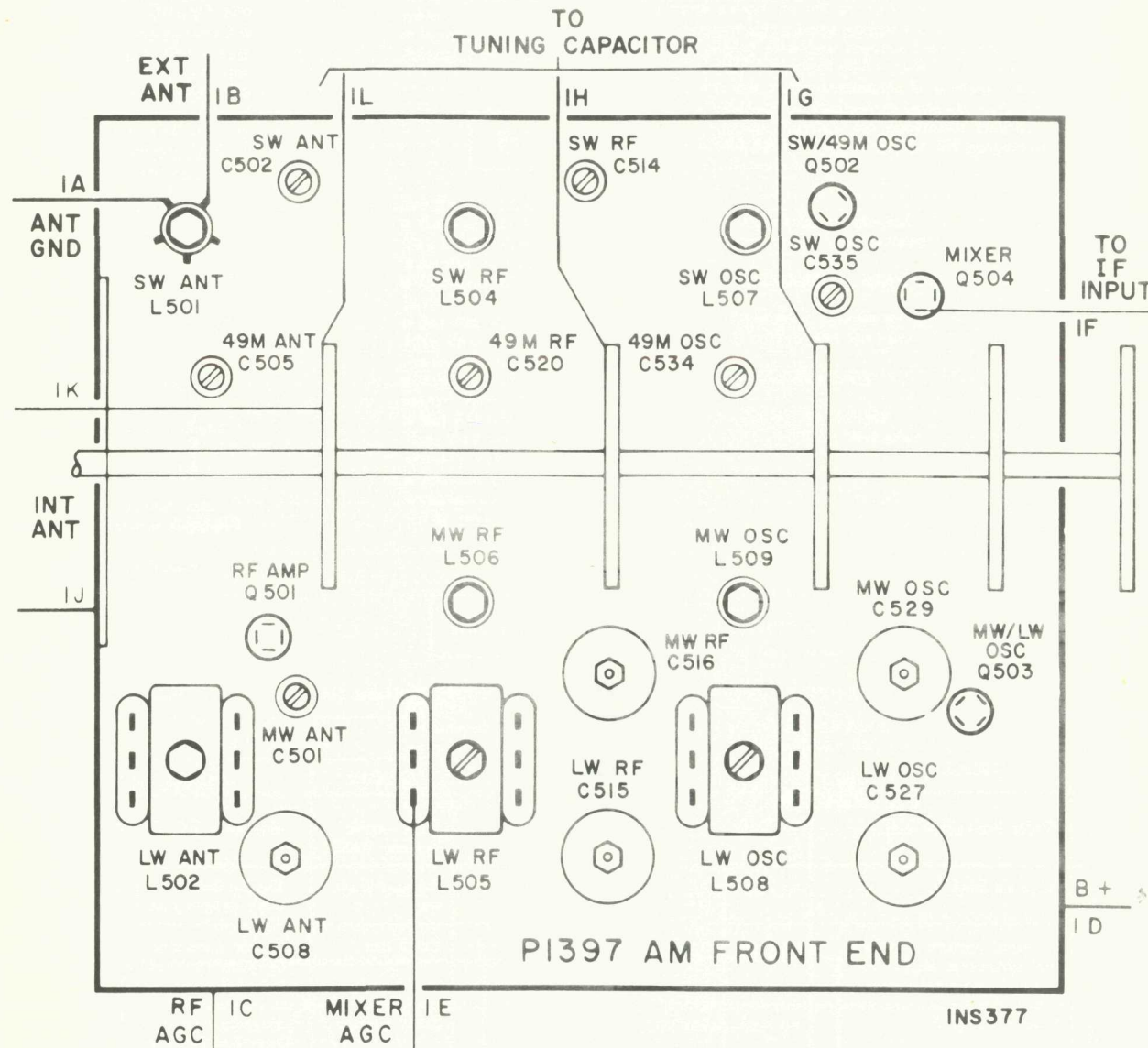



1368-2 FM FRONT END

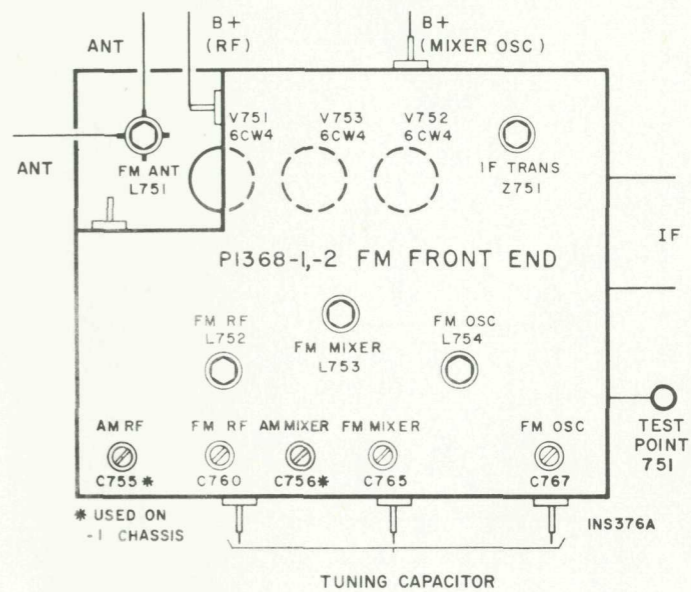
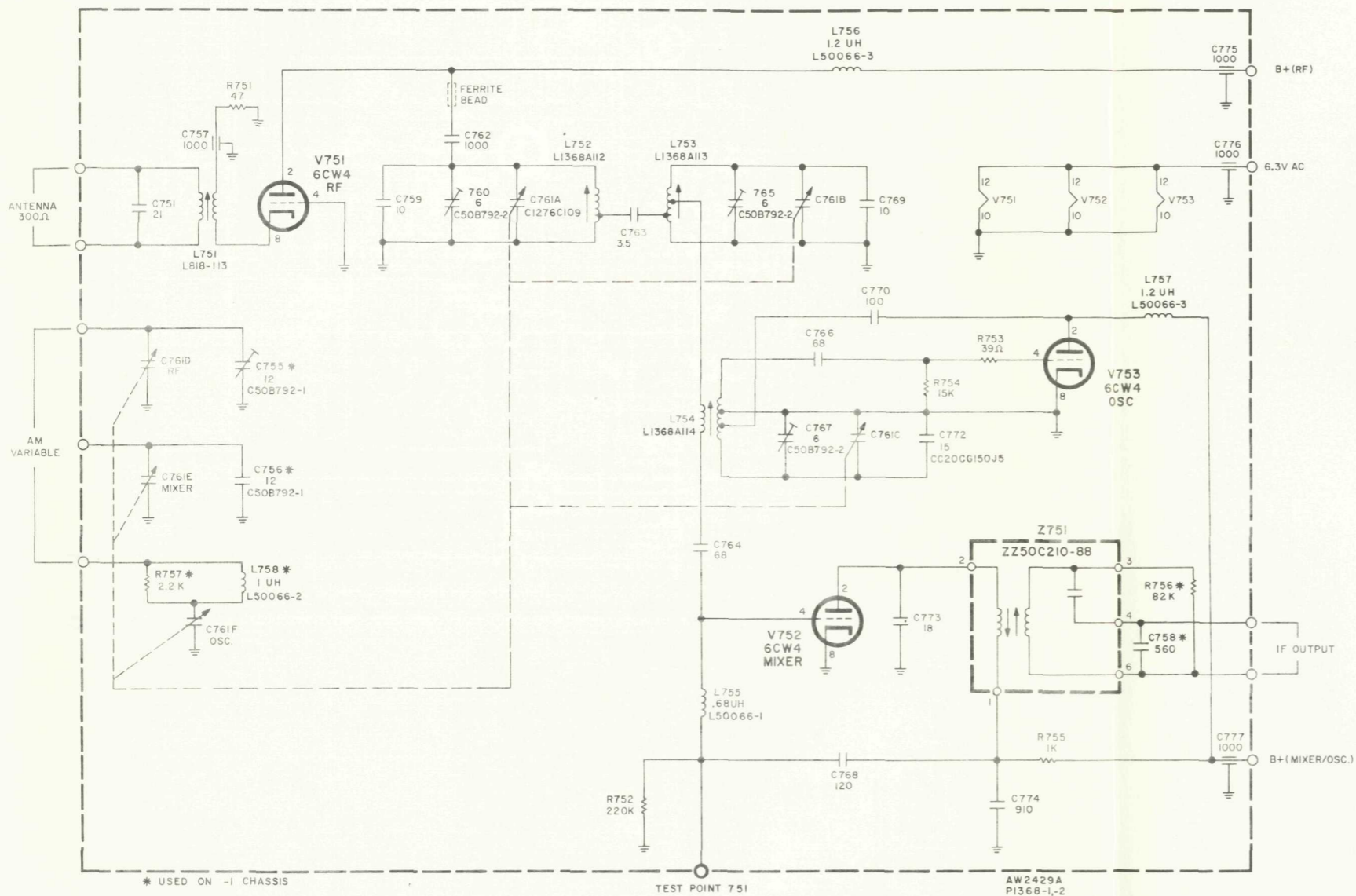







1381 10.7 MHz IF AMPLIFIER

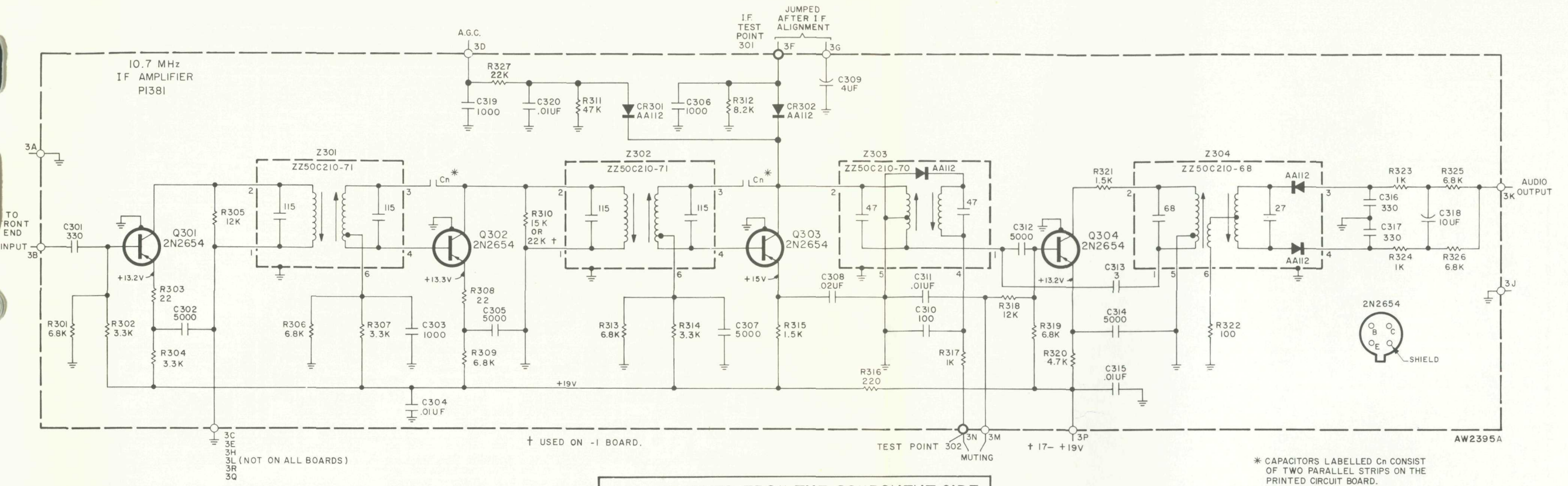

BOARD VIEWED FROM THE COMPONENT SIDE

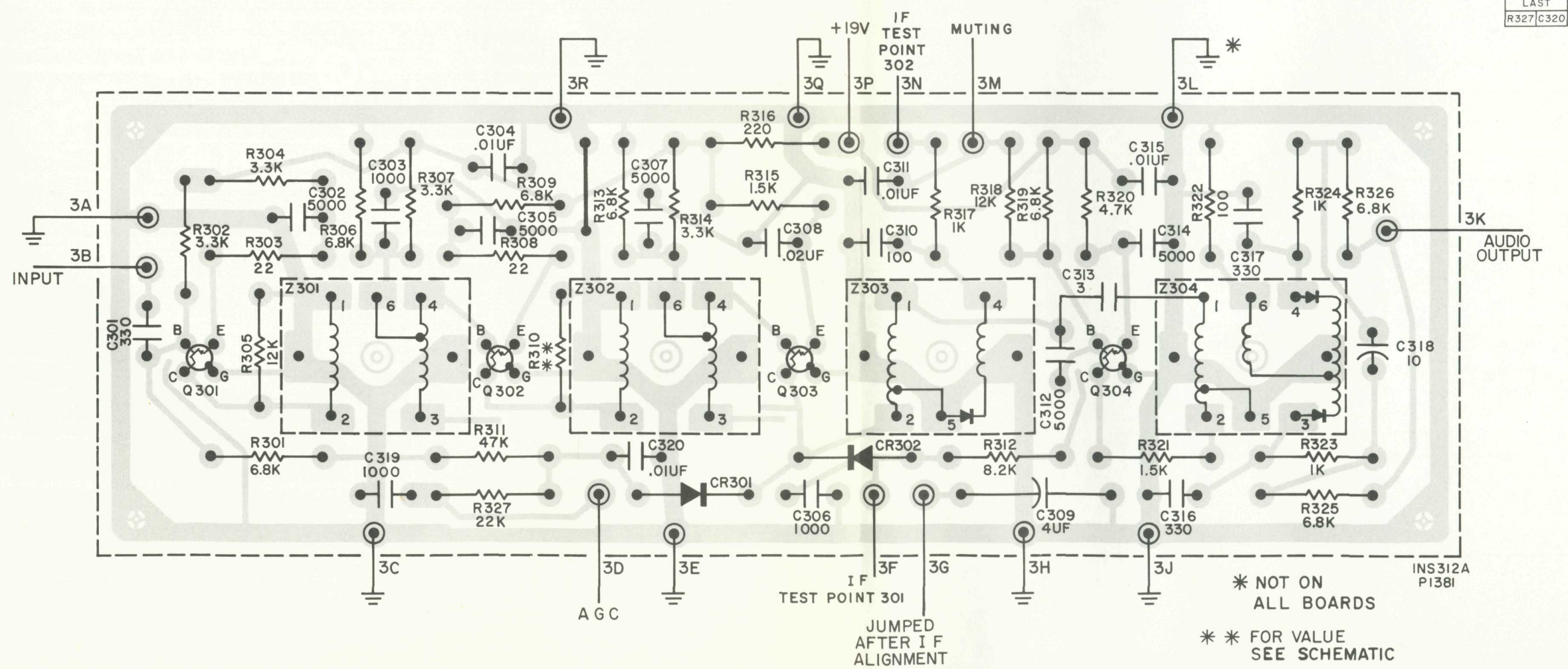

LAST  
R327 C320



# 1471-1, -3 MULTIPLEX DECODER

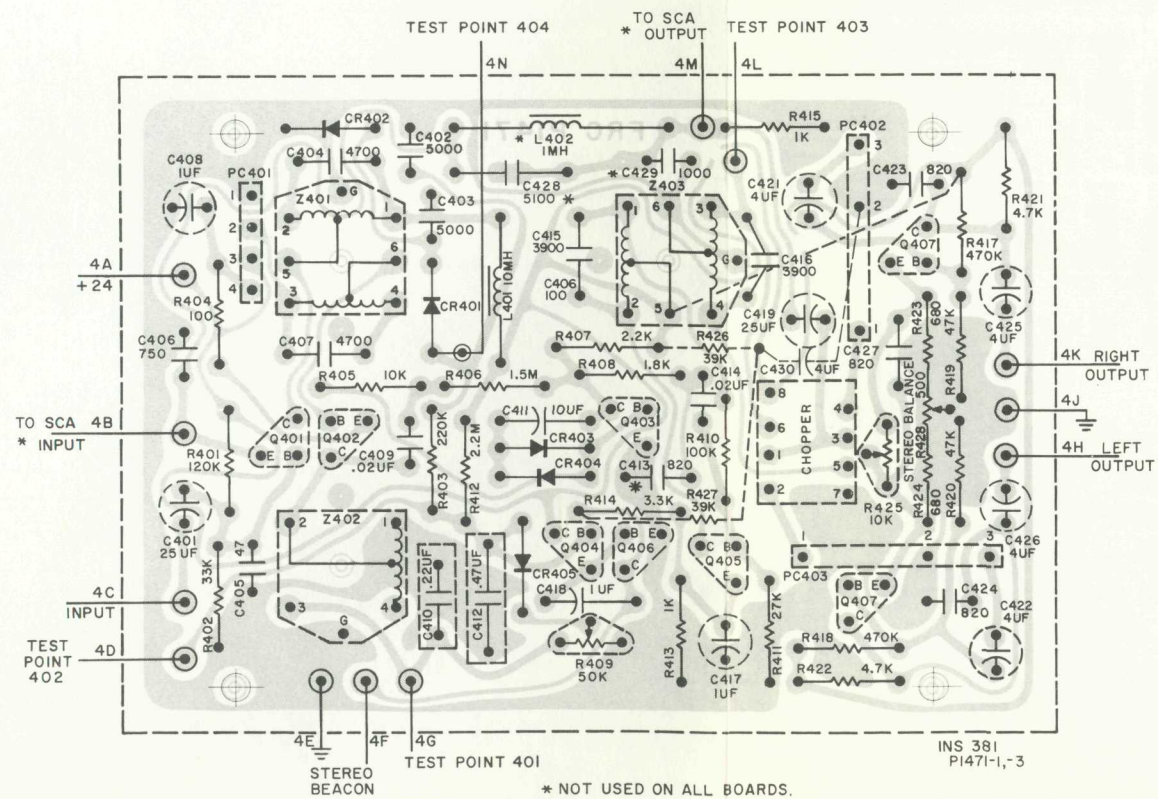
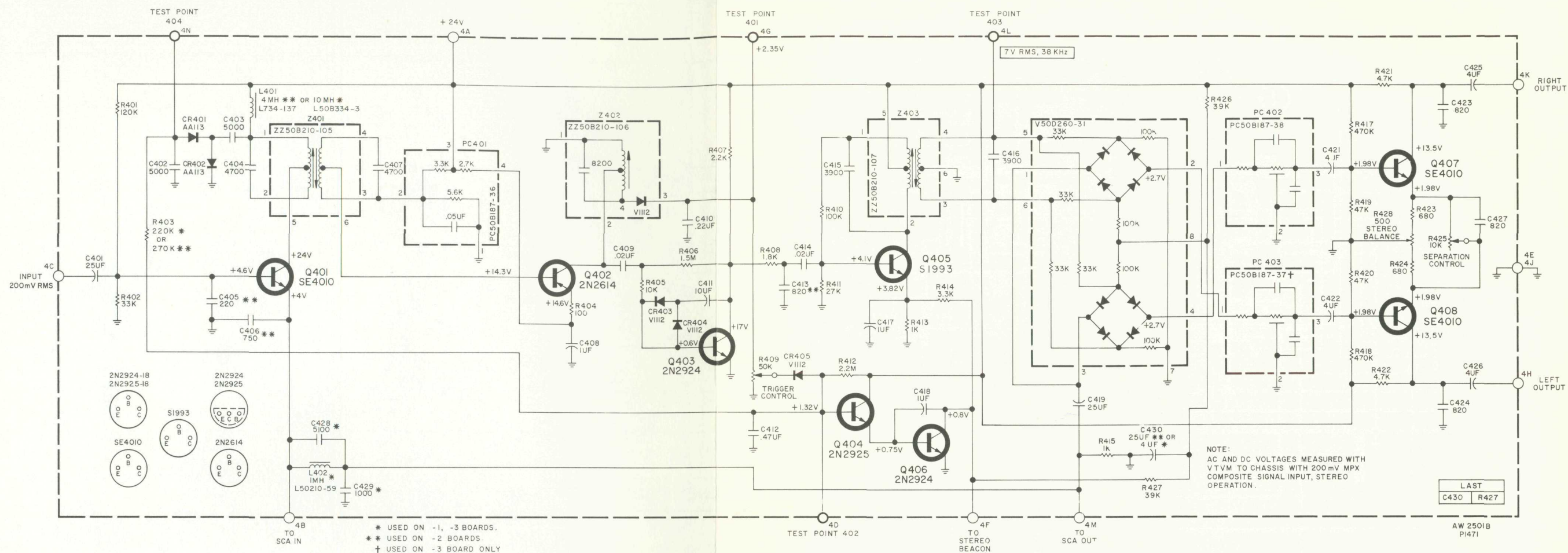

BOARD VIEWED FROM COMPONENT SIDE



# MAIN CHASSIS

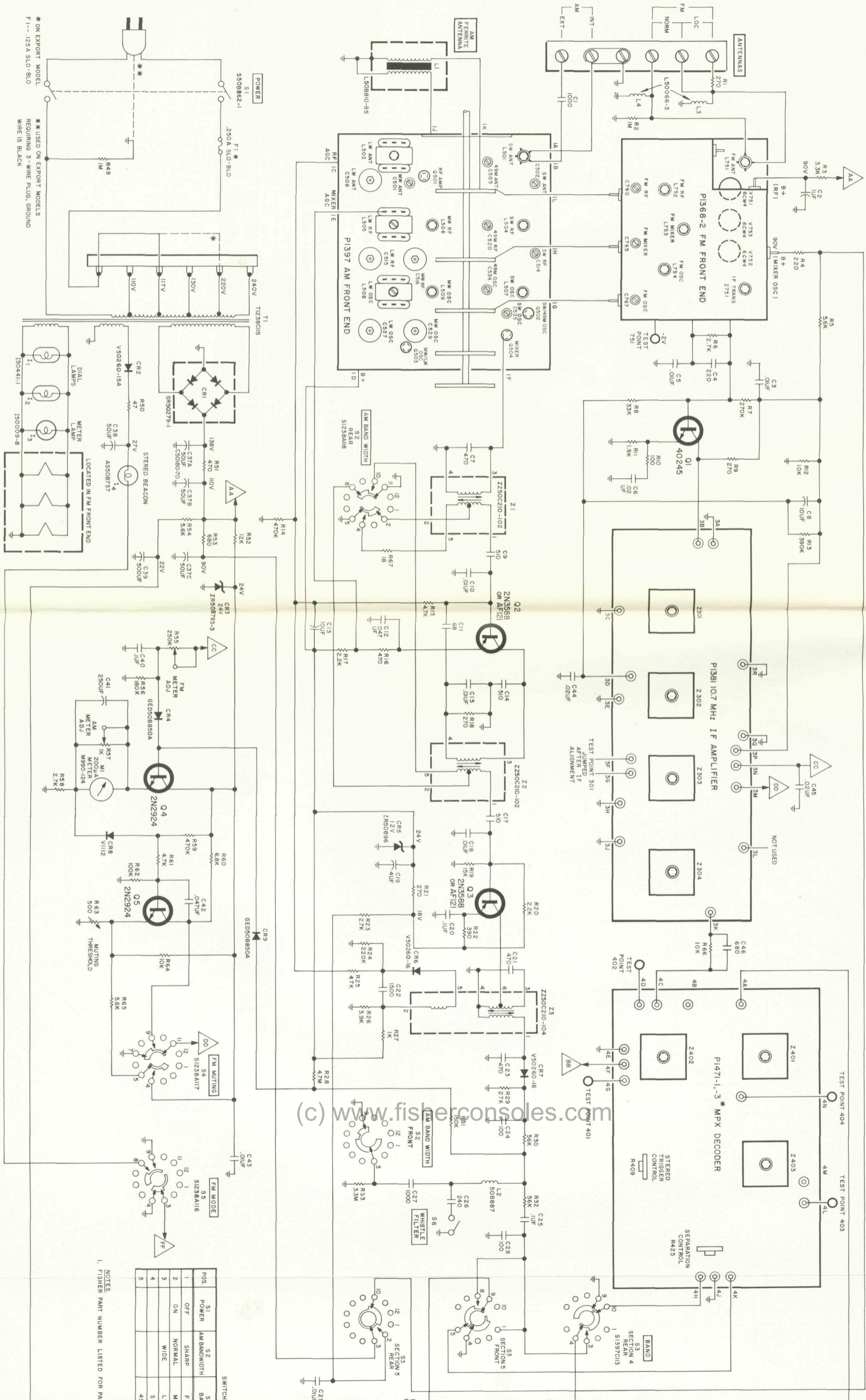

SWITCH

POS	S1	S2	S3
1	POWER	AM BANDWIDTH	BAN
2	OFF	SHARP	FM
3	ON	NORMAL	LW
4		WIDE	SW
5			497

NOTES:  
1. FISHER PART NUMBER LISTED FOR PART

BECAUSE ITS PRODUCTS ARE SUBJECT TO CONTINUOUS IMPROVEMENT, FISHER RADIO CORPORATION RESERVES THE RIGHT TO MODIFY ANY DESIGN OR SPECIFICATION WITHOUT INCURRING ANY OBLIGATION.

\* ON EXPORT MODEL  
F.1--125A SLD-BLO  
REQUIRING 3-WIRE PLUG; GROUND  
WIRE IS BLACK

\* USED ON EXPORT MODELS

(c) www.fisherconsoles.com



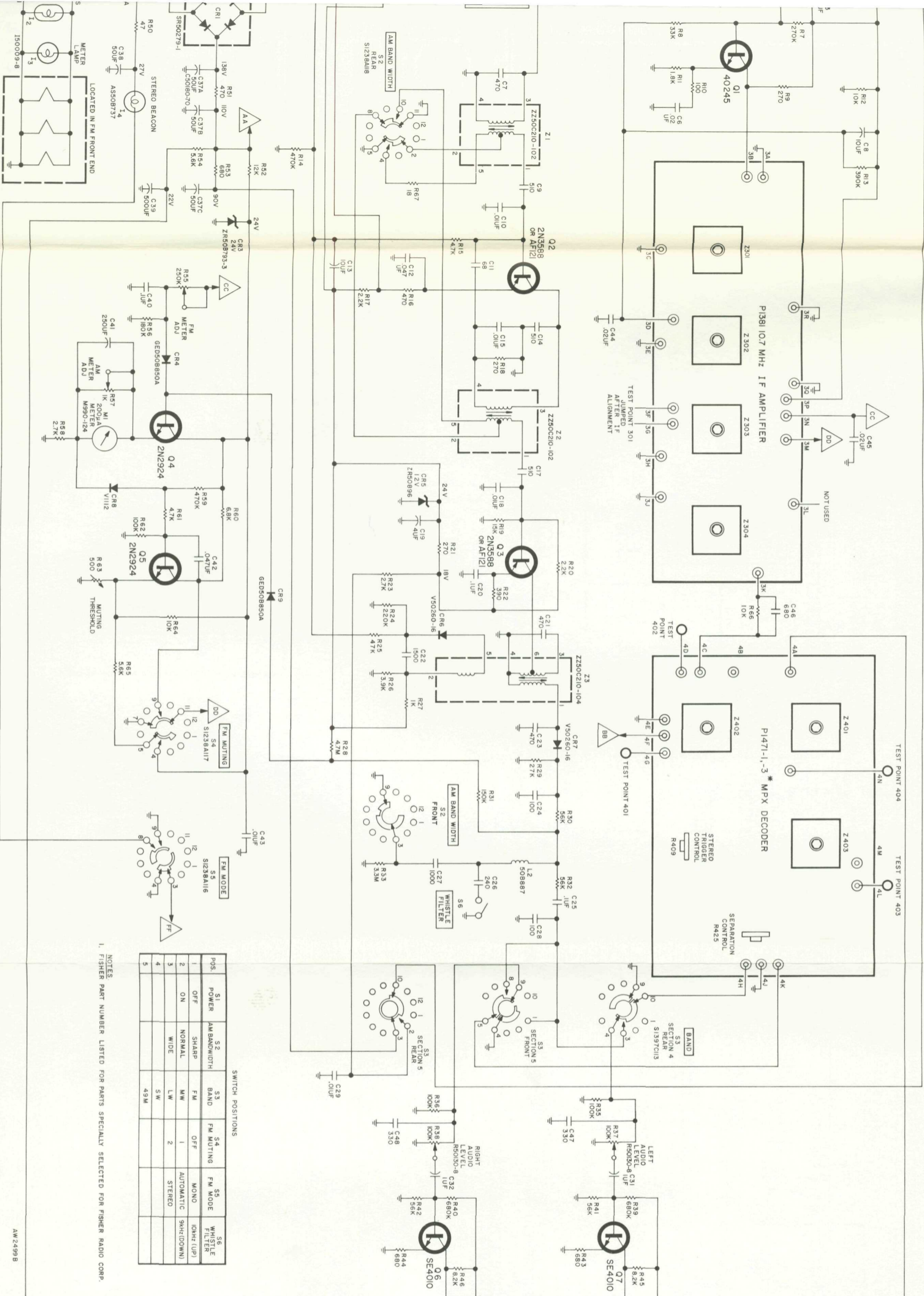

NOTES  
1. FISHER PART NUMBER LISTED FOR PARTS SPECIALLY SELECTED FOR FISHER RADIO CORP.

POS.	S1	S2	S3	S4	S5	S6
1	POWER	AM BANDWIDTH	BAND	FM MUTING	FM MODE	WHISTLE FILTER
2	OFF	SHARP	FM	OFF	MONO	10KHZ (UP)
3	ON	NORMAL	MW	1	AUTOMATIC	9KHZ (DOWN)
4		WIDE	LW	2	STEREO	
5			SW			

SWITCH POSITIONS

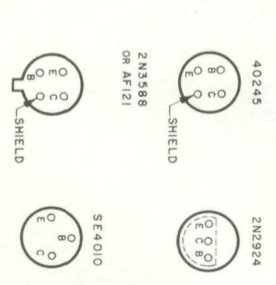

LAST  
C48 1 R67

www.fisherconsoles.com

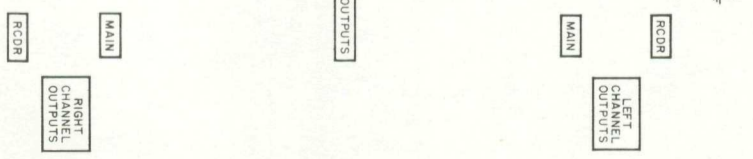



SERVICE NOTES

COMPONENT CONNECTIONS

